

FIRE: Escape Plans Help You Get Out Alive!



Fire and smoke move fast. Flames can burn you. Smoke can hurt your lungs and make it hard to see. If there is a fire in your home, you only have a few minutes to escape. Smoke alarms and a home escape plan can help you and your family get out alive.

- Smoke alarms make a loud sound to let you know that there is a fire and that you need to get out.
- Escape plans help you and your family know HOW to get out quickly and safely.



IF THERE IS A FIRE IN YOUR HOME, WILL YOU AND YOUR FAMILY GET OUT ALIVE?

Keys to Safety in this lesson:

- How to make an escape plan
- How to practice your escape plan

Activities in this lesson:

- Make an Escape Plan
- Practice Your Escape Plan
- Word Scramble
- Word Search
- Crossword Puzzle

Words to Review

Here are some words you will see in this lesson. Review the words and their meanings.

<u>Word</u>	<u>Meaning</u>
escape plan	directions for how you and your family will get out of your home if there is an emergency.
fire drill	a way to practice your escape plan.
smoke alarm	something that makes a loud sound to let you know that there is a fire.
map	a drawing that shows all the rooms, hallways, stairs, windows, and doors on each level of a home.
arrow	a mark like this ➡ to show which way you should go.
meeting place	a safe place for everyone to meet outside near the front of your home.
fire escape	outside stairs you can use to get out of a building if there is a fire or other emergency.
escape ladder	A folding ladder that you keep inside the house so you can get out a window safely if there is a fire. Escape ladders are usually kept in a box or cabinet near the window in rooms on the second or third floor of a home.
get low and go	what you should do if you have to go through a room with smoke.
9-1-1	the telephone number you usually use to call for help in an emergency.

What Is an Escape Plan?

A fire in your home can be very scary and confusing. It can make it hard to think and act. An escape plan tells you how to get out of your home safely. Make and practice an escape plan **BEFORE** there is a fire. Help everyone in your home know what to do to get out safely.



Parts of an Escape Plan

1) Draw a map of each level of your home

- Include all the rooms, hallways, stairs, windows, and doors in the home.
- Also mark where there are roofs, escape ladders, or fire escapes that can help you get outside safely.

2) Have at least two ways out of every room

- Look for doors and windows and mark these on the map. Then make sure the stairs, doors, and windows are clear. Don't block them with furniture or other objects.
- Check all the doors and windows to make sure that they are easy to open.

3) Smoke alarms

- Include smoke alarms on the map. Remember to test all your alarms every month.

4) A safe outdoor meeting place

- Pick a safe place for everyone to meet outside near the front of your home. A good place can be a tree, a telephone pole, a mailbox or in front of your neighbor's home. The meeting place should be far enough from your home that flames and smoke cannot get to it. But it should be close enough so that firefighters will see you when they come to help.

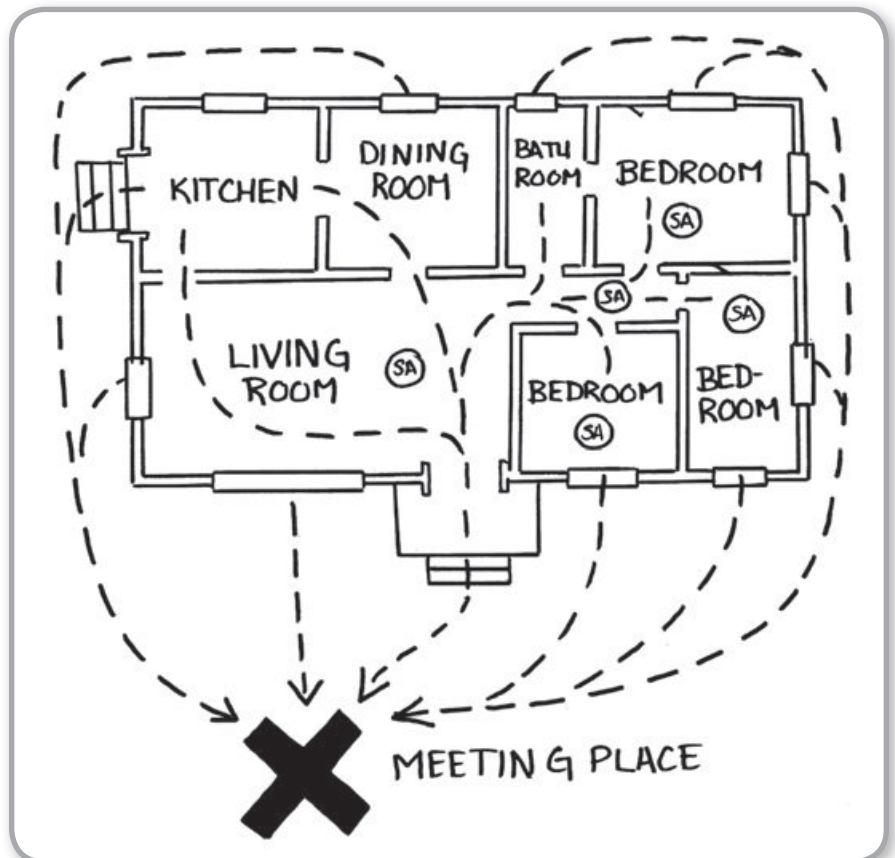

TIP

Helping Others Escape: Some people in your home may need help getting out if there is a fire. You may need to help young children, people with disabilities, or elderly people. Mark where these people sleep on the map. Talk with other adults in the home and make a plan to get everyone out safely.

Activity: Make an Escape Plan

Follow the directions below to make an escape plan for your home. If you live with other people, ask them to help. Use a pencil to draw the map in case you need to make a change. Then go over it with a pen or marker so it will be easy to see. Hang the map up in a place where everyone can see it such as the refrigerator in the kitchen. Practice the plan with a fire drill at least two times every year!

- 1) Draw a map of your home on a blank piece of paper. Include all the rooms, halls, and stairs.
- 2) Draw all the doors, windows, and fire escapes.
- 3) Draw two paths out of every room. Use arrows to show the way out.
- 4) Pick an outside meeting place where everyone will meet after they get out of the home. Draw the meeting place on the map.
- 5) Mark each smoke alarm in your home on the map with **SA**. Remember to test the alarms every month so you know they work.
- 6) Decide who will be responsible for helping young children and others who may need help to get out.

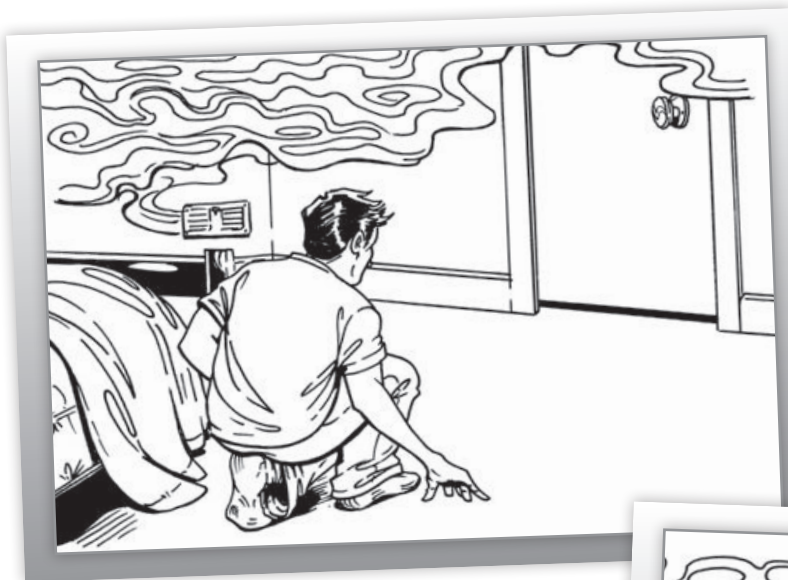

TIP

Get Low and Go - Smoke can kill you. Smoke rises. If there is smoke in the room, you should stay near the floor. Get low and go under the smoke to find your way out.

TIP

Test the Doors – Use the back of your hand to test a closed door for heat before you open it. Feel from the bottom of the door up and the doorknob, and check the crack between the door and door frame before you open it. If any part of the door is warm, there may be fire and smoke on the other side. If all of the parts of the door feel cool, open the door slowly. If smoke or heat comes in, shut the door quickly. If it is not safe to open the door, use another way out.



Activity: Practice Your Escape Plan

Talk about your escape plan with everyone who lives in your home. Make sure everyone knows how to get outside and where to meet when they get out.

Practice your plan with a fire drill two times each year. Have one fire drill at night when people are sleeping.

- 1) An adult in the home should start the drill.
 - Push the test button on your smoke alarm to start the drill.
 - If you live in an apartment, use a bell or other loud noise to start the drill, or ask the landlord or manager to have a drill for the whole building.
- 2) Pick a way out.
- 3) Get outside fast. Get low and go, and test each door before you open it.
- 4) Go to your meeting place.
- 5) In a real fire, get outside first. Then call 9-1-1 or your local emergency number for help.



Push the test button on your smoke alarm to start the drill.



Pick a way out.



Go to your meeting place.

TIP

Stay Safe During Drills! If you are doing a fire drill, do not use ladders or fire escapes. Do not go out windows that are above the ground floor. You could get hurt. Instead, talk about how to do this safely if there is a REAL fire.

TIP

Time Your Drill! In a real fire, you only have about 2 minutes to get out after you hear a smoke alarm. When everyone knows the escape plan, find out how long it takes people to get to your meeting place. Practice the drill until everyone is able to get out in 2 minutes or less.



What If You Can't Get Out?

This is what you should do if you can't get out because of fire or smoke:

- **Keep fire and smoke out:** Keep the door of your room closed. Stuff sheets or blankets into the cracks around the doors to keep smoke and fire out.
- **Call for help:** If there is a phone in the room, call 9-1-1 or the emergency number for your fire department. Tell them where you are.
- **Get fresh air:** After you block the cracks around the door, open a window to get fresh air. Open the window part way and check to see if smoke or fire comes in through the window or through the door of the room. If smoke or fire comes into the room, close the window. If no smoke or fire comes into the room, stand near the window to breathe in fresh air. If there is smoke in the room, get down under it. Hold a t-shirt over your nose and mouth to keep the smoke out of your lungs.
- **Help the firefighters find you:** If you can open a window safely, hang a light colored sheet, towel, or t-shirt out the window to let firefighters know there is someone in the room.

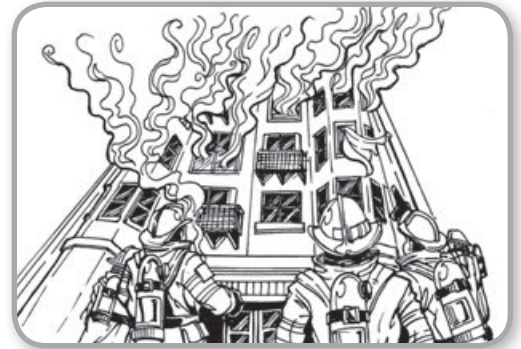

In a real fire:

- 1) Stay **calm**.
- 2) **Think** about your escape plan.
- 3) **Pick the best way out.** Remember to get low under the smoke and to test the doors to see if they are hot. Do not take anything with you.
- 4) When everyone is outside, **call for help** from a cell phone or a neighbor's home. Never call for help from inside your home. Call 9-1-1 or your local emergency number.
- 5) **Stay out.** Never go back into a burning home for any reason, even to save another person. Firefighters are trained to rescue people and put out the fire.

TIP

Talk to your kids about fire safety!

Children learn about fire safety in school, but you should also talk with them about what to do if there is a fire in your home.

- Ask your children to help make and practice an escape plan for your home.
- Walk around your home with them to look for the best ways out. Show them how to get low and go and test the doors for heat.
- Ask your children to help pick an outdoor meeting place. Tell them to go to the meeting place without waiting for other family members if there is a fire drill or real fire.
- Tell them never to hide if there is a fire. Hiding makes it hard for firefighters to find and rescue people.

Other Ways to Stay Safe in a Fire

Get flashlights: Keep a flashlight near every place where someone sleeps. Flashlights will help you see your escape path if the regular lights do not work. Test the flashlights every month when you test your smoke alarms.

Sleep with the door closed: Keep the door to your room closed when you are sleeping. This can give you more time to escape because it keeps the smoke out. Install smoke alarms inside each bedroom and outside each sleeping area.

Help people see your house number: Make sure people can see your house number from the street. This will help firefighters find your home. Check by going outside at night and looking at the number from the street. Put up house numbers near a light, next to your front door, or on your mailbox. Make sure that the numbers are large, in a different color from the color of the house, and are not blocked by anything like a tree or snow.

Apartment tip: If you live in an apartment, make sure the apartment number is on your door. If there is no building number, ask your landlord to put one up.

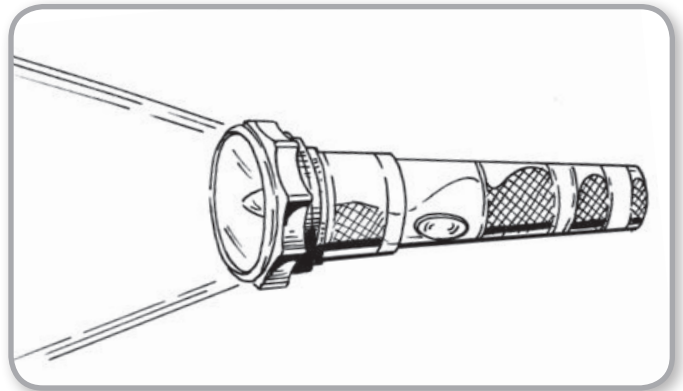

Escape Plan Word Scramble

Unscramble the letters to make words about escape plans and fire safety.

1. osekm _____
2. secpae _____
3. rtaipcce _____
4. oht _____
5. pnal _____
6. irfe _____
7. ehpl _____
8. nbru _____
9. refifghitre _____
10. syftae _____
11. mohe _____
12. ietx _____

Find the answers on page 7.

Escape Plan Word Search

After you unscramble the words in the Escape Plan Scramble, find them in the word search below!

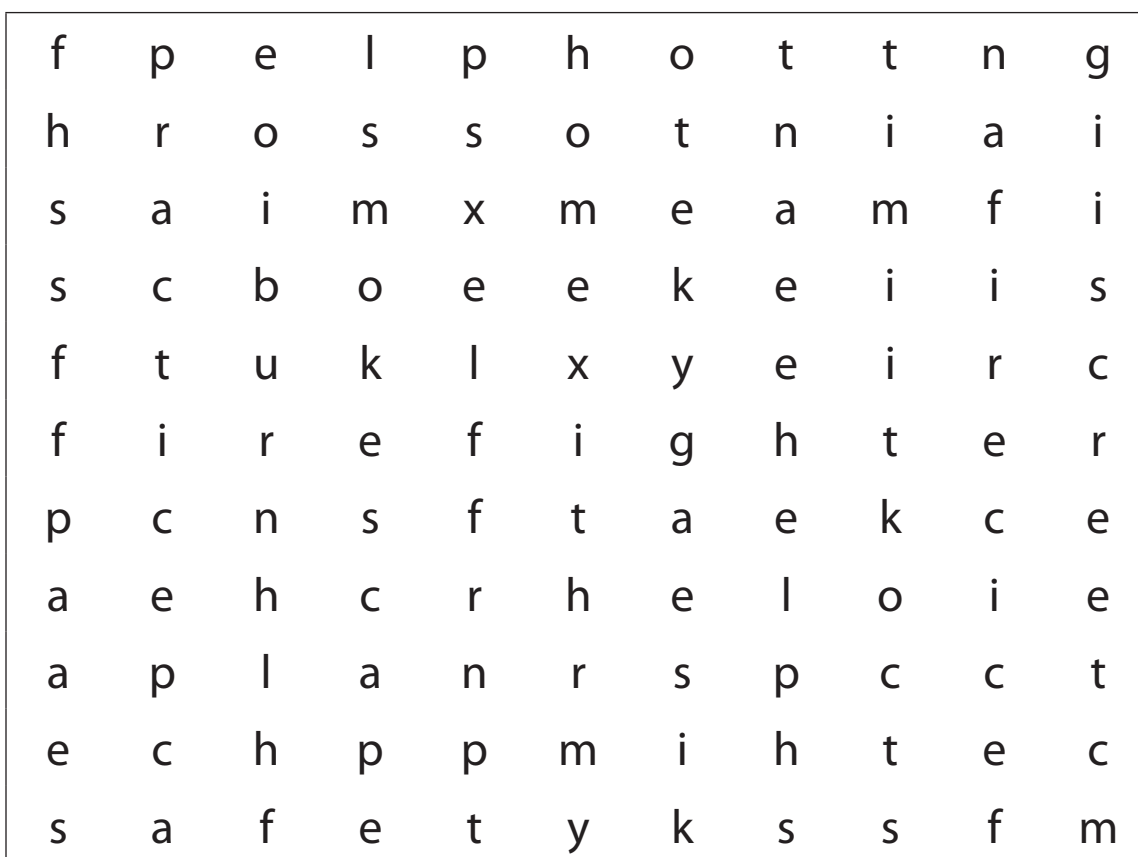

- | | | | |
|----------|------|-------------|--------|
| smoke | hot | help | safety |
| escape | plan | burn | exit |
| practice | fire | firefighter | home |

Find the answers on page 8.



- Crossword Puzzle Answer Key:**
1. smoke alarm
 2. meeting place
 3. fire drills
 4. kitchen
 5. two
 6. escape plan
 7. hand
 8. night
 9. low
 10. outside

- Word Scramble Answer Key:**
1. smoke
 2. escape
 3. practice
 4. hot
 5. plan
 6. fire
 7. help
 8. burn
 9. firefighter
 10. safety
 11. home
 12. exit

Escape Plan Crossword Puzzle

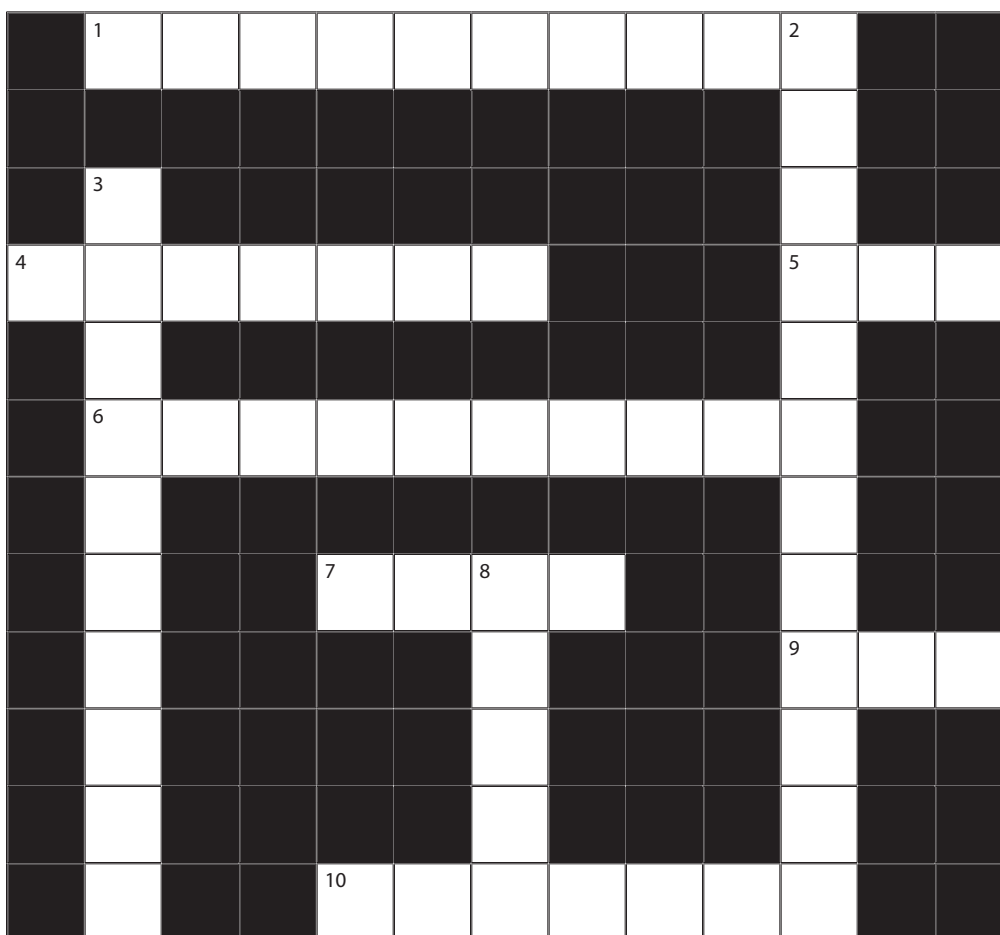

Across

1. This makes a noise to let you know that there is a fire. (2 words)
4. Hang your escape plan map up in a room where everyone can see it. The _____ is a good place.
5. Know at least _____ ways out of each room.
6. Make one of these so you and your family will know how to get out of your home if there is a fire. (2 words)
7. Test every door with the back of your _____ to make sure it is not hot before you open it.
9. "Get _____ and go" if there is smoke in the room.
10. If there is a fire, get _____ before you call for help.

Down

2. Pick a safe _____ where you and your family can find each other if there is a fire. (2 words)
3. Practice your escape plan with two of these each year. (2 words)
8. Practice fire drills during the day and at _____.

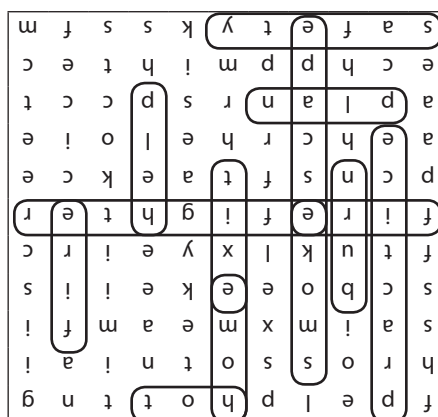

Word Search
Answer Key:

Find the answers on page 7.